

WAGNER

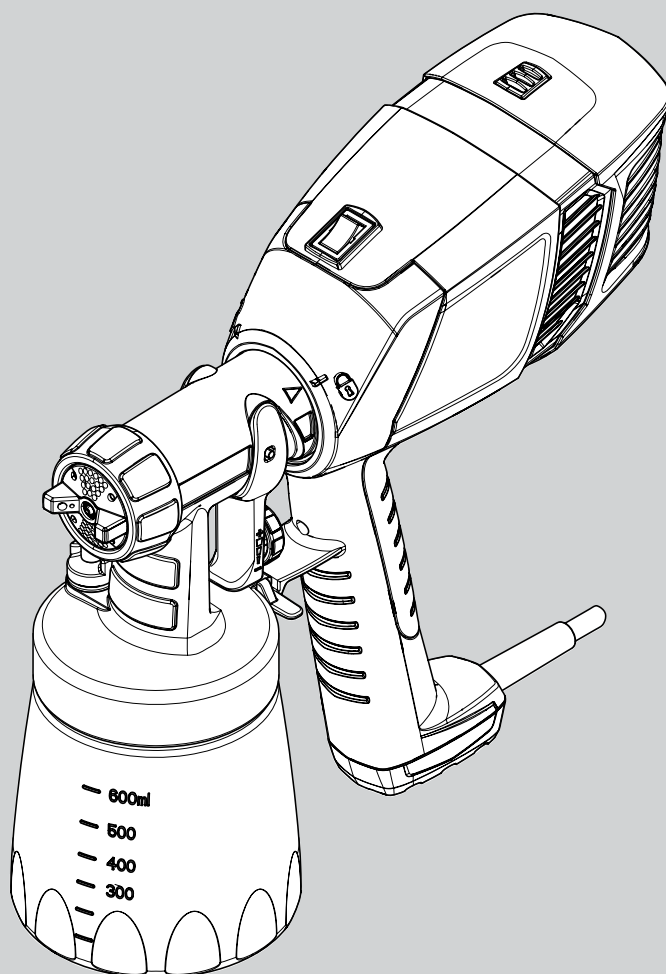

CONTROL SPRAY™ 250

OWNER'S MANUAL

READ THIS MANUAL FOR COMPLETE INSTRUCTIONS

FRANÇAIS - P. 13

ESPAÑOL - P. 25



wagner-group.com

Watch a video manual at www.wagnerspraytech.com/controlspray250

0117 • Form No. 0529627B

IMPORTANT SAFETY INFORMATION





TABLE OF CONTENTS

IMPORTANT SAFETY INFORMATION	2-3
CONTROLS AND FUNCTIONS	4-5
SETUP	6-7
SPRAYER CONTROLS	8
SPRAYING	9
CLEANUP	10
MAINTENANCE	11
TROUBLESHOOTING	12
PARTS LIST	37-38
WARRANTY	39

EXPLANATION OF SYMBOLS

Read all safety information before operating the equipment. Save these instructions.

To reduce the risks of fire or explosion, electrical shock and the injury to persons, read and understand all instructions included in this manual. Be familiar with the controls and proper usage of the equipment.

	Indicates a hazardous situation which, if not avoided, could result in death or serious injury.
IMPORTANT:	This symbol indicates a potential hazard to you or to the equipment. Important information that tells how to prevent damage to the equipment or how to avoid causes of minor injuries will follow.
	Danger of electric shock
	Danger of fire from solvent and paint fumes
	Danger of explosion from solvent, paint fumes and incompatible materials
	Notes give important information which should be given special attention.

GROUNDING INSTRUCTIONS

This product must be grounded. In the event of an electrical short circuit, grounding reduces the risk of electric shock by providing an escape wire for the electric current. This product is equipped with a cord having a grounding wire with an appropriate grounding plug. The plug must be plugged into an outlet that is properly installed and grounded in accordance with all local codes and ordinances.

	WARNING - Improper installation of the grounding plug can result in a risk of electric shock.
-----------------------------------------------------------------------------------	------------------------------------------------------------------------------------------------------

If repair or replacement of the cord or plug is necessary, do not connect the green grounding wire to either flat blade terminal. The wire with insulation having a green outer surface with or without yellow stripes is the grounding wire and must be connected to the grounding pin.

Check with a qualified electrician or serviceman if the grounding instructions are not completely understood, or if you are in doubt as to whether the product is properly grounded. Do not modify the plug provided. If the plug will not fit the outlet, have the proper outlet installed by a qualified electrician.

This product is for use on a nominal 120 volt circuit and has a grounding plug that looks like the plug illustrated below. Make sure that the product is connected to an outlet having the same configuration as the plug. No adapter should be used with this product.

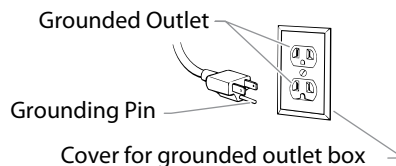

IMPORTANT ELECTRICAL INFORMATION

Use only a 3-wire extension cord that has a 3-blade grounding plug and a 3-slot receptacle that will accept the plug on the product. Make sure your extension cord is in good condition. When using an extension cord, be sure to use one heavy enough to carry the current your product will draw. An undersized cord will cause a drop in line voltage resulting in loss of power and overheating. A 14 gauge or 12 gauge cord is recommended. If an extension cord is to be used outdoors, it must be marked with the suffix W-A after the cord type designation. For example, a designation of SJTW-A would indicate that the cord would be appropriate for outdoor use.

IMPORTANT:	Household use only. Intended for indoor/outdoor use ONLY with materials having flashpoint above 100°F (38°C).
-------------------	---------------------------------------------------------------------------------------------------------------

IMPORTANT SAFETY INFORMATION

SAFETY HAZARDS

	HAZARD: EXPLOSION OR FIRE Flammable vapors, such as solvent and paint vapors, in work area can ignite or explode.
-----------------------------------------------------------------------------------	-----------------------------------------------------------------------------------------------------------------------------

PREVENTION:

- Do not spray flammable or combustible materials near an open flame, pilot lights or sources of ignition such as hot objects, cigarettes, motors, electrical equipment and electrical appliances. Avoid creating sparks from connecting and disconnecting power cords.
- For use with only water-based or mineral spirit-type materials with a minimum flash point of 100°F (38°C) — Do not spray or clean with liquids having a flash point of less than 100°F (38°C). Flash point is the temperature at which a fluid can produce enough vapor to ignite.
- Verify that all containers and collection systems are grounded to prevent static discharge.
- Connect to a grounded outlet and use grounded extension cords (electric models only). Do not use a 3 to 2 adapter.
- Keep spray area well ventilated. Keep a good supply of fresh air moving through the area to keep the air within the spray area free from accumulation of flammable vapors.
- Do not smoke in the spray area.
- Do not operate light switches, engines, or similar spark producing products in the spray area.
- Keep area clean and free of paint or solvent containers, rags, and other flammable materials.
- Know the contents of the paint and solvents being sprayed. Read all material Safety Data Sheets (SDS) and container labels provided with the paints and solvents. Follow the paint and solvent manufacture's safety instructions.
- Fire extinguisher equipment shall be present and working.

	HAZARD: ELECTRIC SHOCK This product can cause injury due to electric shock.
-------------------------------------------------------------------------------------	---------------------------------------------------------------------------------------

PREVENTION:

- Power cord must be connected to a grounded circuit.
- Never submerge electrical parts.
- Never expose the equipment to rain. Store indoors.
- Keep electrical cord plug and spray gun trigger free from paint and other liquids. Never hold the cord at plug connections to support the cord. Failure to observe may result in an electrical shock.

	HAZARD: GENERAL This product can cause severe injury or property damage.
-----------------------------------------------------------------------------------	------------------------------------------------------------------------------------

PREVENTION:

- Always wear appropriate gloves, eye protection, clothing and a respirator or mask when painting. Hazardous vapors – Paints, solvents, insecticides, and other materials can be harmful if inhaled or come in contact with body. Vapors can cause severe nausea, fainting or poisoning.
- Do not operate or spray near children. Keep children away from equipment at all times.
- Do not overreach or stand on an unstable support. Keep effective footing and balance at all times.
- Stay alert and watch what you are doing.
- Do not operate the unit when fatigued or under the influence of drugs or alcohol.
- Never aim spray gun at any part of the body.
- Follow all appropriate local, state, and national codes governing ventilation, fire prevention, and operation.
- The United States Government Safety Standards have been adopted under the Occupational Safety and Health Act (OSHA). These standards, particularly part 1910 of the General Standards and part 1926 of the Construction Standards should be consulted.
- Use only manufacturer authorized parts. User assumes all risks and liabilities when using parts that do not meet the minimum specifications and safety devices of the turbine manufacturer.
- Power cord must be connected to a grounded circuit.
- Do not spray outdoors on windy days.

CONTROLS AND FUNCTIONS

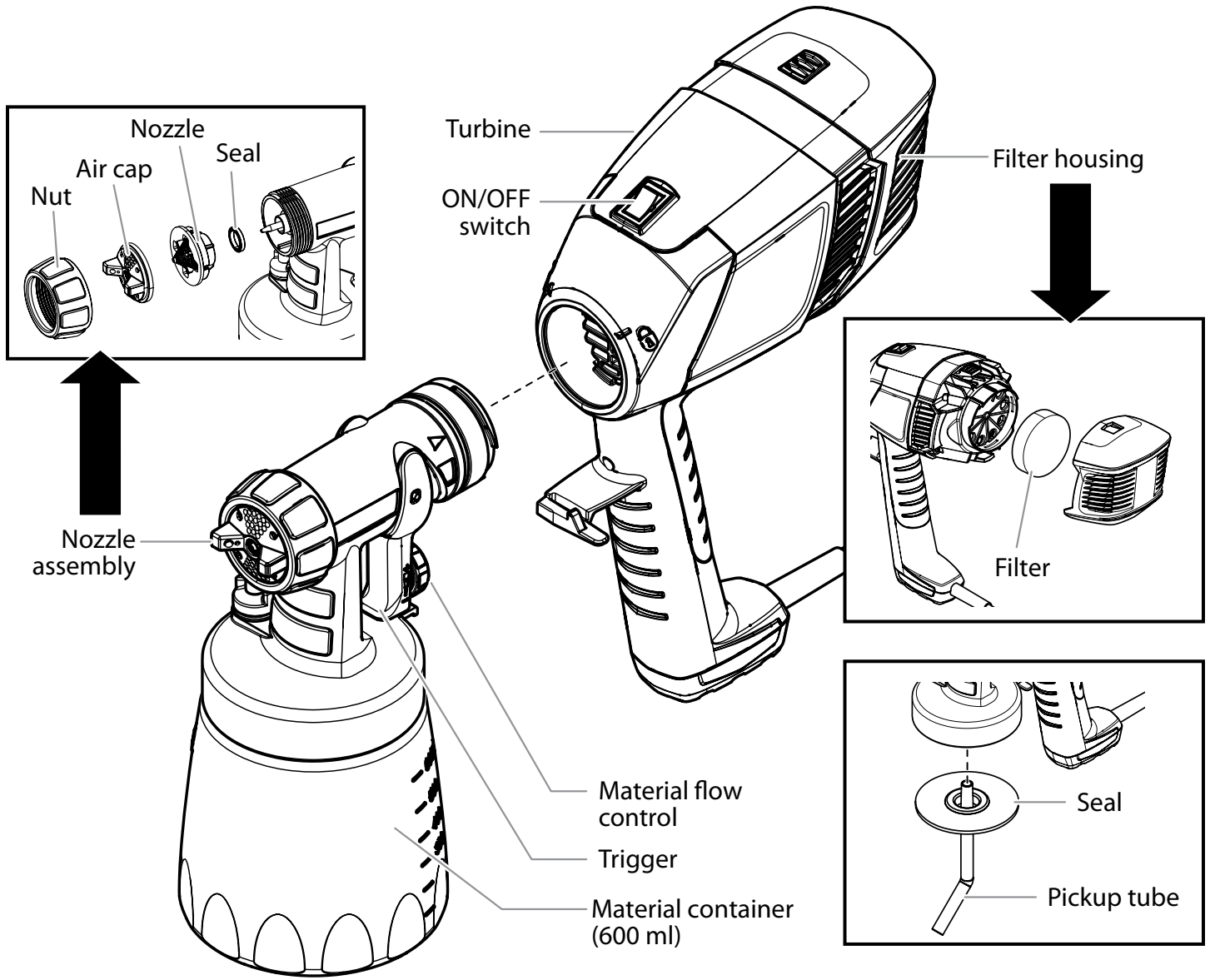

CONTROLS AND FUNCTIONS

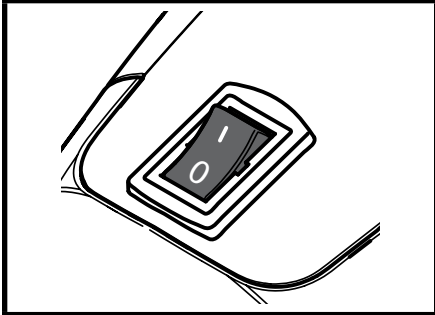

ON / OFF SWITCH

The ON/ OFF switch turns the turbine ON (I) and OFF (0).

No spray material will be delivered until trigger is pulled.

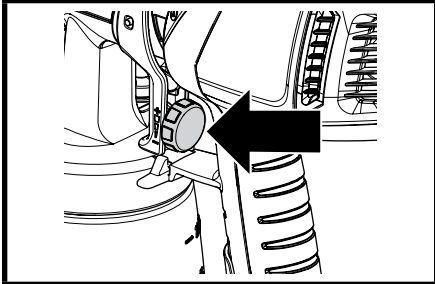

MATERIAL FLOW CONTROL

The material flow control knob determines the amount of spray material that is sprayed from the spray nozzle.

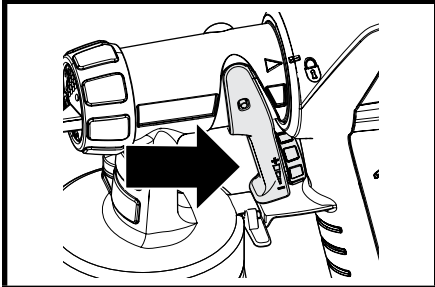

TRIGGER

Pulling the trigger will deliver spray material from the material container to the nozzle assembly, where it is sprayed.

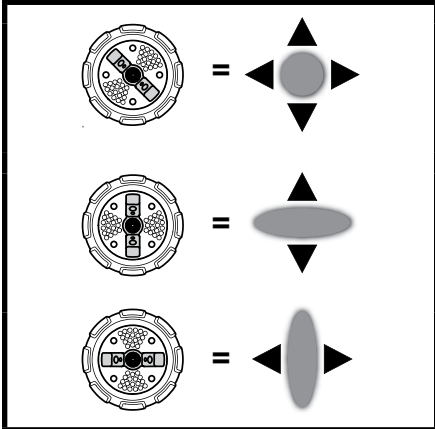

AIR CAP

Round pattern (use 'up and down' or 'side to side' spraying motion)



Horizontal pattern (use 'up and down' spraying motion)

Vertical pattern (use 'side to side' spraying motion)

SETUP

	For a video showing how to set up the Control Spray, visit: www.wagnerspraytech.com/controlspray250
-----------------------------------------------------------------------------------	----------------------------------------------------------------------------------------------------------------------------------------------------------------------------

MATERIAL PREPARATION

	Material to be sprayed may need to be strained to remove any impurities in the paint which may enter and clog the system. Impurities in the paint will give poor performance and a poor finish.
	Latex paints and primers are not recommended to be used with this sprayer.



SPRAYABLE MATERIALS

- Sealers
- Transparent stain
- Semi-Transparent stain
- Solid stains
- Lacquer (thinning may be necessary)
- Urethanes
- Decorative paints (thinning may be necessary)
- Furniture paints (thinning may be necessary)
- Latex and oil-based paints (thinning may be necessary)

*THINNING THE MATERIAL

Before spraying, the material being used may need to be thinned with the proper solvent as specified by the material manufacturer. Never exceed the thinning advice given by the coating manufacturer.

If thinning is necessary, use the proper solvent as specified by the material manufacturer. Never exceed the thinning advice given by the coating manufacturer.

	Only thin the material if absolutely necessary to improve spray performance. Optimal spray performance should be achieved simply by adjusting the various controls on the unit.
	Do not thin with materials that have a flashpoint below 100°F (38°C).

SETUP



For a video showing how to set up the Control Spray, visit:
www.wagnerspraytech.com/controlspray250

ASSEMBLY



NEVER point the spray gun at any part of the body.
Make sure the power cord is unplugged.

1. Stir the spraying material thoroughly.
2. Fill the container. Use a strainer to remove any particles.
(see **Thinning the Material**, previous page, if thinning is required).
3. Align the pickup tube -
 - A If spraying downward, the angled end of the pickup tube should be pointing toward the front of the nozzle.
 - B If spraying upward, the angled end of the pickup tube should be pointing toward the rear of the nozzle.



Make sure the pickup tube is inserted as far as it will go to ensure a tight fit.

4. Carefully screw the cup back onto the nozzle assembly. Tighten firmly.
5. Align the arrow on the nozzle with the “unlock” symbol on the spray gun handle.
6. Insert and twist the nozzle into the handle toward the “lock” symbol on the handle. The tab below the trigger will lock the two pieces into place.

IMPORTANT:

If the unit has already been used, make sure the nozzle seal is in place (see page 10).

Do not pull trigger at any time if the turbine is not running. Paint will drip from the nozzle.

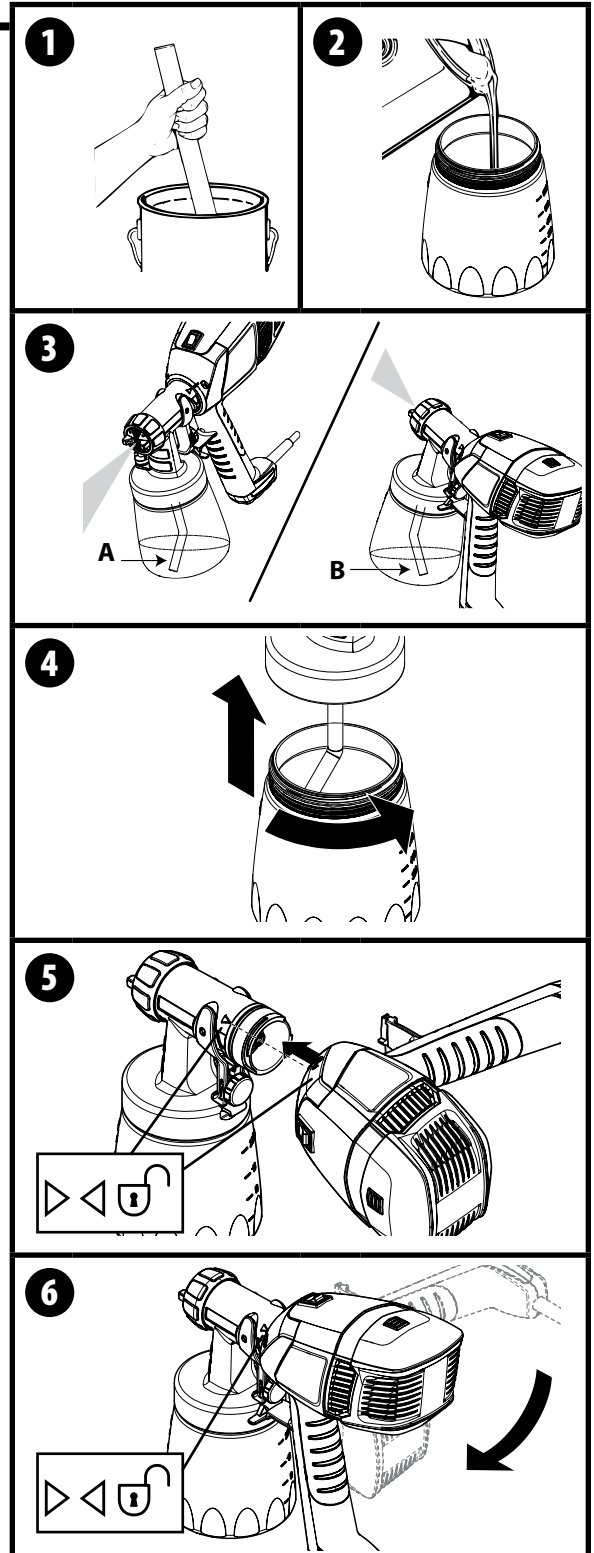

SPRAYER CONTROLS



For a video showing Control Spray 250 spraying tips and best practices, visit:
www.wagnerspraytech.com/controlspray250

MATERIAL FLOW CONTROL



The material flow control will be factory-set at its lowest setting out of the box. Adjust as needed.

- Turn the knob out (counterclockwise) for less flow. Generally, low material flow is needed for spraying smaller surface areas, such as corners, lattice, or spindles.
- Turn the knob in (clockwise) for increased flow. Generally, high material flow is needed for spraying large surface areas, such as fences and decks.

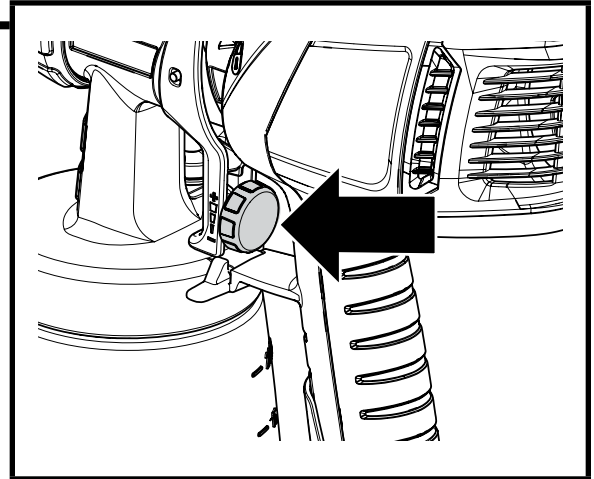

AIR CAP / PATTERN ADJUSTMENT



Adjust the spray pattern by turning the air cap ears.

The air cap position will determine the movement direction of the spray gun.

1. Round pattern:

Use up and down, or side to side spraying motion, depending upon the object being sprayed.

2. Vertical pattern:

Use side-to-side motion during spraying.

3. Horizontal pattern:

Use up and down motion during spraying.

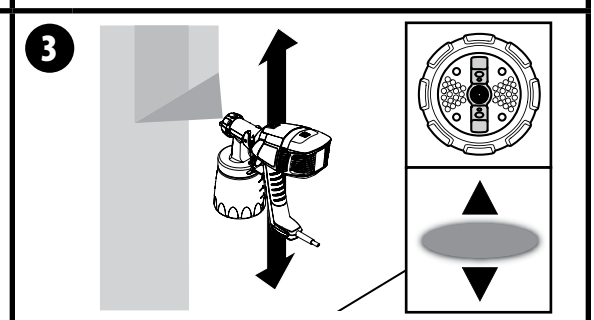
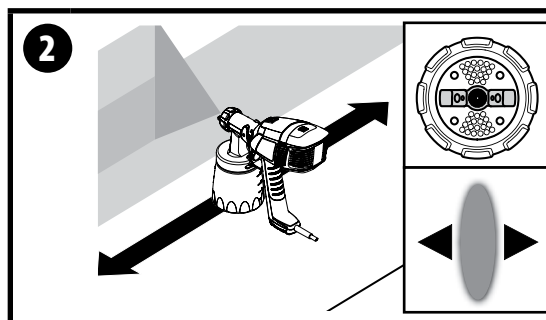
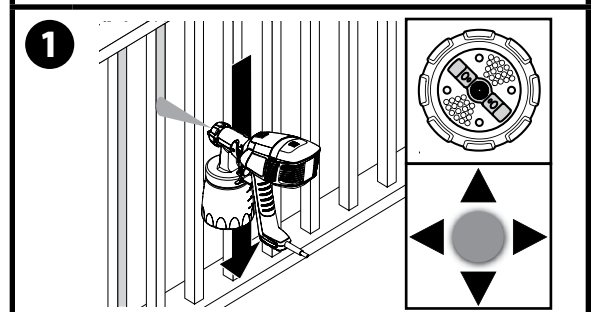
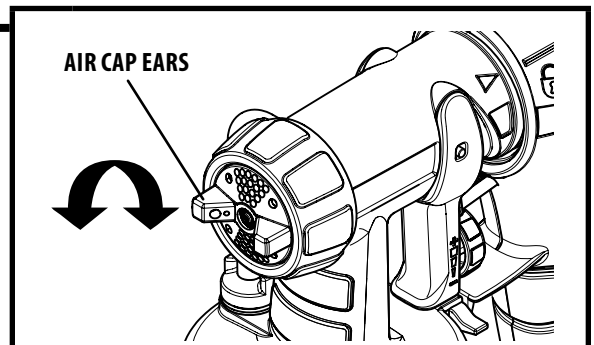

SPRAYING

	<p>For a video showing Control Spray 250 spraying tips and best practices, visit: www.wagnerspraytech.com/controlspray250</p>
-----------------------------------------------------------------------------------	-------------------------------------------------------------------------------------------------------------------------------------------------------------------------------------------------

HOW TO SPRAY PROPERLY

- Turn the ON/OFF switch to ON (I) to turn on the turbine. No material will spray until the trigger is activated.
- Position the spray gun perpendicular to the spray surface.
- Spray parallel to the surface with straight and full passes at a consistent speed as illustrated, right.
- Always apply a thin coat of material on the first pass and allow to dry before applying a second, slightly heavier coat.
- When spraying, always trigger the spray gun after the spray pass has begun and release the trigger before stopping the pass. Always keep the gun pointed squarely at the spray surface and overlap passes slightly to obtain the most consistent and professional finish possible.

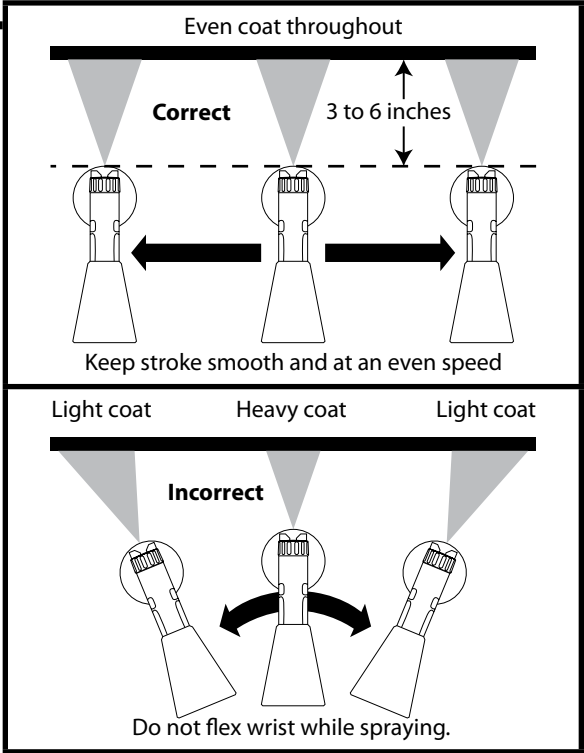

	<p>Frequently wipe the nozzle tip with a damp rag when spraying to remove dried material.</p>
-------------------------------------------------------------------------------------	-----------------------------------------------------------------------------------------------



PRACTICE YOUR TECHNIQUE

Practice your technique (use provided poster).

- **Get closer.** The spray gun should be 3-6 inches away from the spray object.
- **Full passes.** Spray the material in straight and full passes, not short waves.
- **Light coats.** For a finer finish, coat lightly during first pass, then cover completely on second pass. .

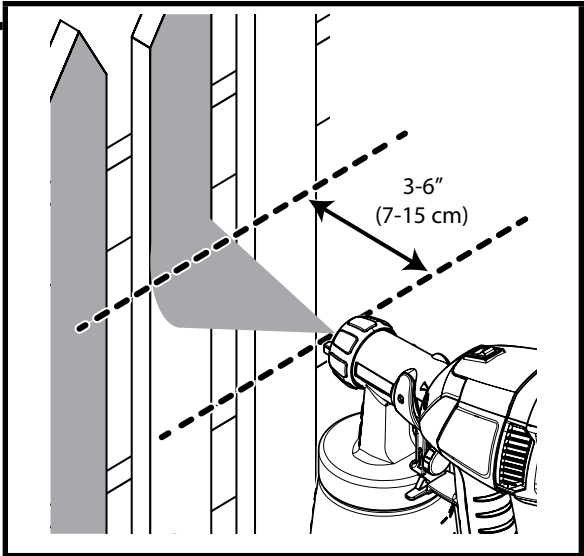

	<p>DO NOT pull the trigger when the turbine is turned OFF. Spray material will leak from the nozzle.</p>
	<p>If after following the guidelines on these two pages you are still not getting the spray performance you need, refer to the 'Troubleshooting' section on page 12.</p>



CLEANUP

	<p>For a video showing cleanup of the Control Spray 250, visit: www.wagnerspraytech.com/controlspray250</p>
-----------------------------------------------------------------------------------	-------------------------------------------------------------------------------------------------------------------------------------------------------------------------------

CLEANUP NOTES

	<p>When cleaning, use the appropriate cleaning solution (warm, soapy water for water-based coatings, and mineral spirits for oil-based coatings).</p>
	<p>Special cleanup instructions for use with flammable solvents (must have a flashpoint above 100°F (38°C):</p> <ul style="list-style-type: none"> • Always flush spray gun outside. • Area must be free of flammable vapors. • Cleaning area must be well-ventilated. • Do not submerge turbine!
	<p>For basic quick-cleaning between color changes, fill the material container with cleaning solution and spray the cleaning solution through the gun and into a waste container.</p>

1. Turn turbine OFF.
 Remove the container and empty any remaining material. Thoroughly rinse the material container with warm, soapy water (or mineral spirits for oil-based materials).
2. Disassemble the spray gun and clean all parts with warm soapy water (or mineral spirits for oil-based materials).
3. Clean the air vent (a) on the suction tube with a soft bristled cleaning brush.
4. Separate the turbine from the nozzle. Clean the rear of the nozzle (b) with the appropriate cleaning solution. Use a thin layer of petroleum jelly to lubricate the O-ring (c).
5. Reassemble the spray gun.

	<p>When replacing the nozzle seal, make sure the groove in the seal is facing outward. Make sure the tab in the spray gun head is aligned with one of the notches in the nozzle.</p>
-------------------------------------------------------------------------------------	-------------------------------------------------------------------------------------------------------------------------------------------------------------------------------------------------

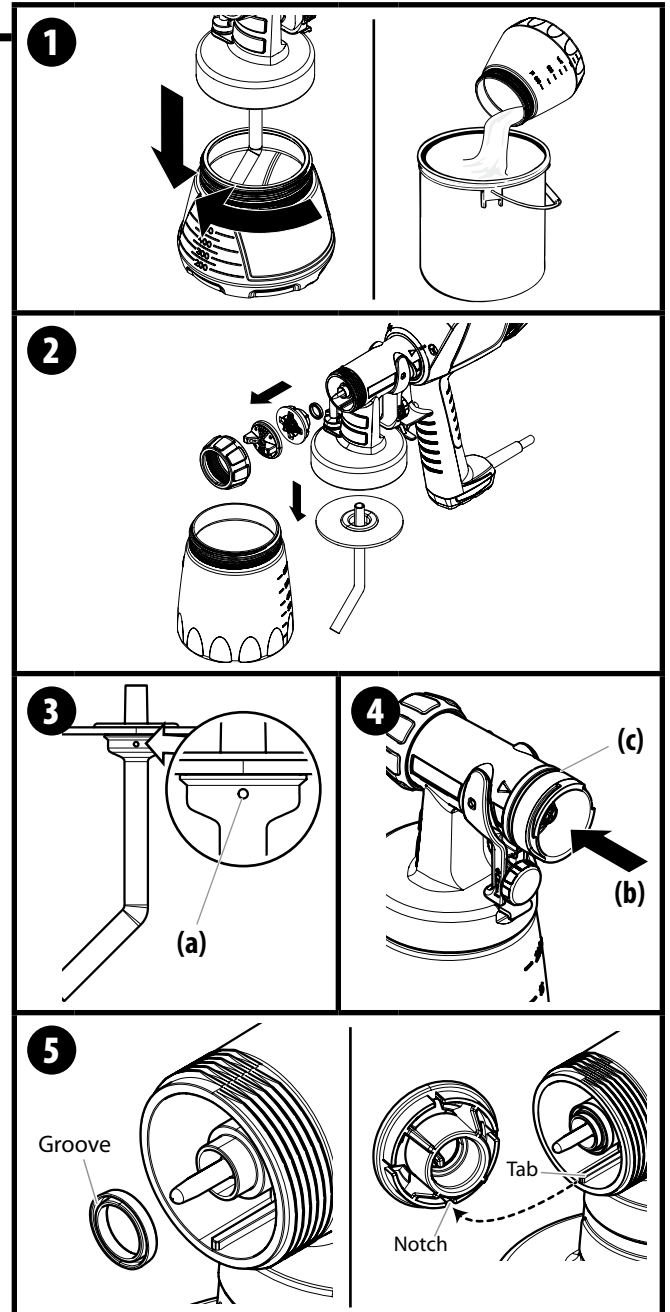

MAINTENANCE

CLEANING THE FILTER

IMPORTANT:

Before every use, you should inspect the air filter in the turbine to see if it is excessively dirty. If it is dirty, follow these steps to replace it.

Never operate your unit without the air filters. Dirt could be sucked in and interfere with the function of the unit.

1. Press the tab at the rear of the turbine. Slide the rear housing off of the back of the turbine.
2. Remove the dirty filter from the turbine and replace with a new one. The smooth side of the air filter must be placed toward the turbine.

Secure the cover back onto the turbine.

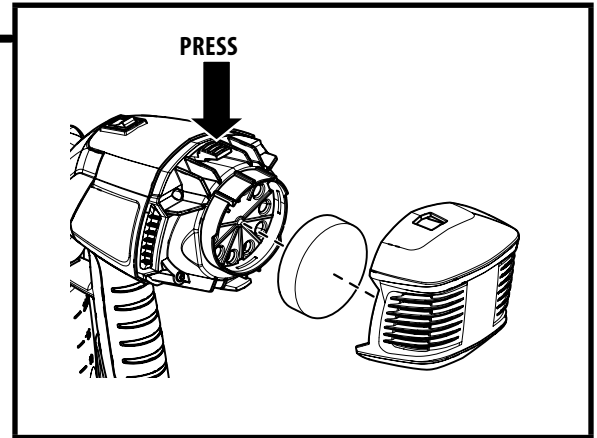

CLEANING THE AIR VALVE TUBE



If spray material ever enters the air valve tube, follow the steps below.

1. Pull the air tube (a) at the top from the nozzle. Screw off the valve cover (b).
Remove the valve seal (c). Clean all the parts carefully. Make sure to remove any material from valve seal housing area (d).

IMPORTANT:

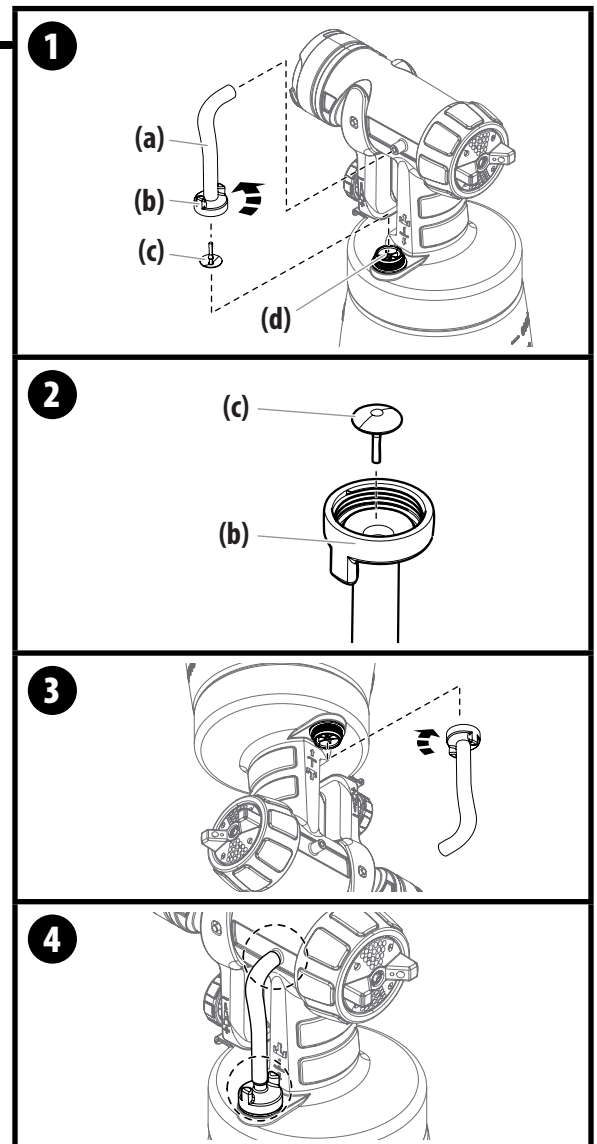

The air tube and valve seal (c) are only solvent-resistant to a limited extent. Do not immerse in solvent, only wipe.

2. Place the valve seal (c) in the valve cover (b) with the pin facing into the tube. Installing the valve seal into the valve cover will be much easier if the valve cover is inverted.
3. Turn the nozzle upside down and screw on the valve cover (with valve seal inside) from underneath. Turning the nozzle upside down will prevent the valve seal from falling out of the valve cover during reinstallation.
4. Place the air tube on the valve cover and on the nipple at the nozzle.



TROUBLESHOOTING

PROBLEM	CAUSE	SOLUTION
Problem A: Little or no material flow	<ol style="list-style-type: none"> 1. Nozzle clogged. 2. Suction tube clogged. 3. Material flow setting too low. 4. Suction tube loose. 5. No pressure build up in container. 6. Air filter clogged. 7. Spray material too thick. 8. Nozzle seal missing or worn. 	<ol style="list-style-type: none"> 1. Clean. 2. Clean. 3. Increase material flow setting. 4. Remove and replace as tightly as possible. 5. Tighten container. Check the air vent hole on the pick up tube - clean if clogged. 6. Change 7. Thin*. 8. Replace (extras provided).
Problem B: Material leaking	<ol style="list-style-type: none"> 1. Nozzle loose. 2. Nozzle worn. 3. Nozzle seal missing or worn. 4. Material build-up on air cap and nozzle 	<ol style="list-style-type: none"> 1. Tighten. 2. Replace. 3. Replace (extras provided). 4. Clean.
Problem C: Spray pattern too thick, runs and sags	<ol style="list-style-type: none"> 1. Material flow setting too high. 2. Applying too much material. 3. Nozzle clogged. 4. Air filter clogged. 5. Too little pressure build-up in container. 6. Spray material too thick. 	<ol style="list-style-type: none"> 1. Decrease material flow setting. 2. Adjust material flow or increase movement of spray gun. 3. Clean. 4. Change. 5. Tighten container. 6. Thin*.
Problem D: Spray jet pulsates	<ol style="list-style-type: none"> 1. Material in container running out. 2. Air filter clogged. 	<ol style="list-style-type: none"> 1. Refill. 2. Change.
Problem E: Too much overspray	<ol style="list-style-type: none"> 1. Gun too far from spray object. 	<ol style="list-style-type: none"> 1. Reduce distance (3"-6" is ideal).
Problem F: Pattern is very light and splotchy	<ol style="list-style-type: none"> 1. Moving the spray gun too fast. 2. Material flow setting too low. 	<ol style="list-style-type: none"> 1. Adjust material flow or decrease movement of spray gun. 2. Increase material flow setting.

	*Only thin the material as a last resort to improve spray performance. Optimal spray performance should be achieved simply by adjusting the various controls on the unit.
	This unit contains no servicable electrical parts. Do not attempt to service yourself. Store indoors with the cord wrapped around the turbine handle.
	Have you tried the recommendations above and are still having problems? In the United States, to speak to a customer service representative, call our Technical Service at 1-800-328-8251. See www.wagnerspraytech.com in the "Contact Us" section for Technical Service hours.

PARTS LIST • LISTE DE PIÈCES • LISTA DE PIEZAS

Replacement parts available by calling customer service

On peut obtenir des pièces de rechange en appelant le Service à la clientèle.

Los repuestos están disponibles llamando al servicio a clientes.

1-800-328-8251

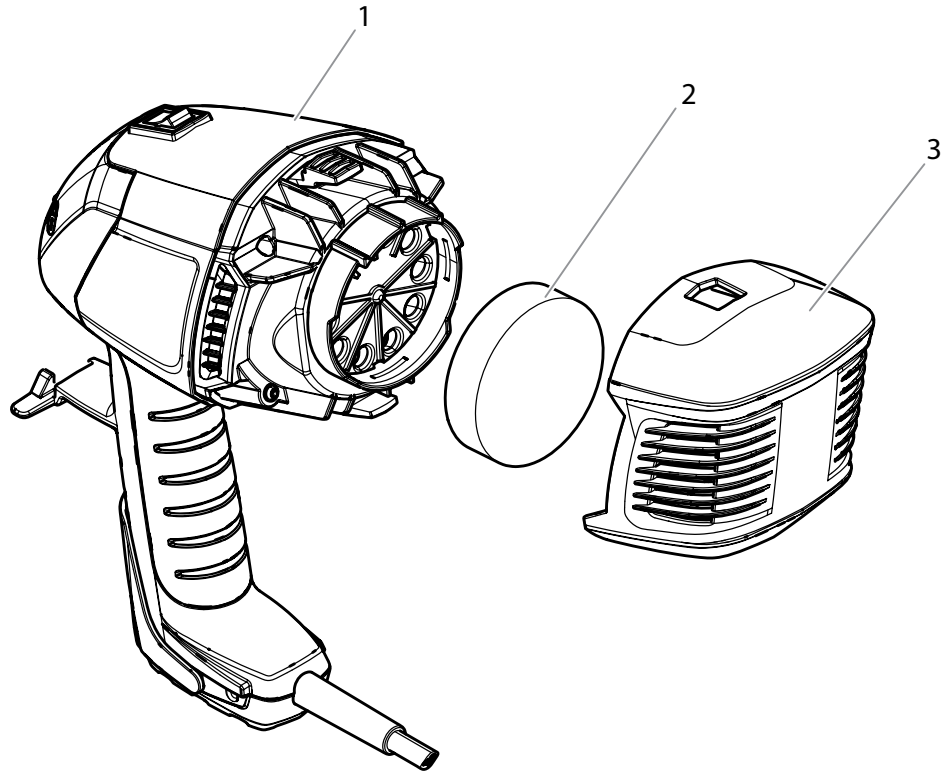

#	Part No. N° de pièce Pieza No.	English Description	Français Description	Español Descripción	Qty. Qte. Cant.
1	-----	Turbine (includes item 2-3)	Turbine (inclut de pièce 2-3)	Turbina (incluye le artículo 2-3)	1
2	2307279	Filter	Filtre	Filtro	2
3	2314371	Filter housing	Boîtier du filtre	Alojamiento de filtro	1

COMPATIBLE ACCESSORIES • ACCESSOIRES COMPATIBLES • ACCESORIOS COMPATIBLES

Part No. N° de pièce Pieza No.	English Description	Français Description	Español Descripción
0529013	Detail Finish nozzle	Buse de Detail Finish	Boquilla de Detail Finish
	<ul style="list-style-type: none"> Controlled coverage, speed with smooth finish Detail projects and finer finishing 	<ul style="list-style-type: none"> Vitesse de couverture contrôlée avec finition lisse Projets détaillés et finition fine 	<ul style="list-style-type: none"> Velocidad de cobertura controlada con acabado uniforme Proyectos de detalle y acabado más fino
0529257	Control Finish nozzle	Buse de Control Finish	Boquilla de Control Finish
	<ul style="list-style-type: none"> Medium coverage speed with semi-smooth finish Finishing and painting small projects 	<ul style="list-style-type: none"> Vitesse de couverture moyenne avec finition semi-lisse Finition et projets de peinture plus petits 	<ul style="list-style-type: none"> Velocidad de cobertura media con acabado semiuniforme Acabado y pintado de proyectos pequeños
0529014	iSpray nozzle	Buse de iSpray	Boquilla de iSpray
	<ul style="list-style-type: none"> Fast coverage speed with a roller-like finish Indoor and outdoor painting and staining, medium to large projects 	<ul style="list-style-type: none"> Vitesse moyenne rapide avec finition roulante Peintures et colorations intérieures et extérieures, projets de moyenne à grande taille 	<ul style="list-style-type: none"> Velocidad media rápida con un acabado en forma de rodillo Pintura y tinción en interiores y exteriores, proyectos de mediano a grande

PARTS LIST • LISTE DE PIÈCES • LISTA DE PIEZAS

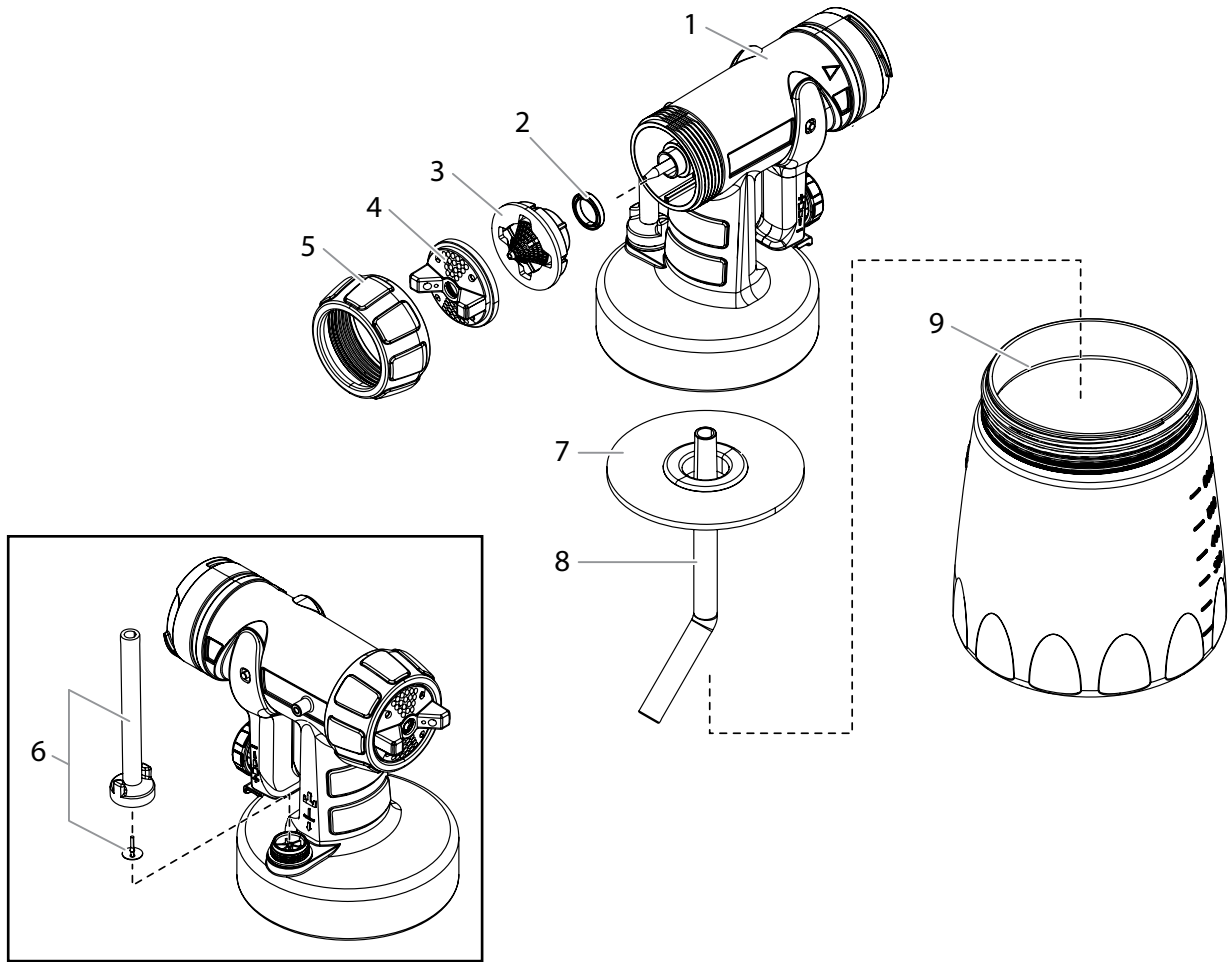

#	Part No. N° de pièce Pieza No.	English Description	Français Description	Español Descripción	Qty. Qte. Cant.
1	0529257	Nozzle assembly (includes items 1-9)	Ensemble de buse (includ des pièces 1 à 9)	Ensamblaje de boquilla (incluye los articulos 1-9)	1
2	0417706	Nozzle seal	Joint d'étanchéité de buse	Sello de boquilla	1
3	2362878	Nozzle	Buse	Boquilla	1
4	2362877	Air cap	Chapeau d'air	Tapa de aire	1
5	2362873	Connecting nut	Écrou d'assemblage	Tuerca de conexión	1
6	2304027	Tube / Valve seal	Tube / Joint de clapet	Tube / Junta de la válvula	1
7	2370527	Container seal	Joint d'étanchéité de réservoir	Sello de recipiente	1
8	2359280	Pickup tube	Tube d'aspiration	Tubo de succión	1
9	2359272	Material container (800 ml)	Réservoir de liquide (800 ml)	Recipiente (800 ml)	1

LIMITED WARRANTY • GARANTIE LIMITÉE • GARANTÍA LIMITADA

HVLP PAINT SPRAY EQUIPMENT

This product, manufactured by Wagner Spray Tech Corporation (Wagner), is warranted against defects in material and workmanship for one year following date of purchase if operated in accordance with Wagner's printed recommendations and instructions. This warranty does not cover damage resulting from improper use, accidents, user's negligence or normal wear. This warranty does not cover any defects or damages caused by service or repair performed by anyone other than a Wagner Authorized Service Center.

ANY IMPLIED WARRANTY OF MERCHANTABILITY OR FITNESS FOR A PARTICULAR PURPOSE IS LIMITED TO ONE YEAR FOLLOWING DATE OF PURCHASE. WAGNER SHALL NOT IN ANY EVENT BE LIABLE FOR ANY INCIDENTAL OR CONSEQUENTIAL DAMAGES OF ANY KIND, WHETHER FOR BREACH OF THIS WARRANTY OR ANY OTHER REASON. THIS WARRANTY DOES NOT APPLY TO ACCESSORIES.

THIS PRODUCT IS DESIGNED FOR HOME USAGE ONLY. IF USED FOR COMMERCIAL OR RENTAL PURPOSES, THIS WARRANTY APPLIES ONLY FOR 30 DAYS FROM DATE OF PURCHASE.

If any product is defective in material and/or workmanship during the applicable warranty period, return it with proof of purchase, transportation prepaid to any Wagner Authorized Service Center. (Service Center listing is enclosed with this product.) Wagner's Authorized Service Center will either repair or replace the product (at Wagner's option) and return it to you, postage prepaid.

SOME STATES DO NOT ALLOW LIMITATIONS ON HOW LONG AN IMPLIED WARRANTY LASTS OR THE EXCLUSION OF INCIDENTAL OR CONSEQUENTIAL DAMAGES, SO THE ABOVE LIMITATION AND EXCLUSION MAY NOT APPLY TO YOU. THIS WARRANTY GIVES YOU SPECIFIC LEGAL RIGHTS, AND YOU MAY ALSO HAVE OTHER RIGHTS WHICH VARY FROM STATE TO STATE.

PULVÉRISATEUR DE PEINTURE HVLP

Cet article fabriqué par Wagner Spray Tech Corporation (Wagner) est garanti contre tout défaut de fabrication et de matériaux pour une période d'un an suivant la date d'achat, à condition qu'il soit utilisé conformément aux recommandations et aux instructions écrites de Wagner. La garantie ne couvre pas les dommages résultant d'un mauvais emploi, d'un accident, d'une négligence de la part de l'utilisateur ou de l'usure normale de l'article. Elle ne couvre pas non plus les défauts ou les dommages découlant de services d'entretien ou de réparations assurées par tout autre établissement qu'un centre de service après-vente agréé de Wagner.

TOUTE GARANTIE TACITE RELATIVE AUX QUALITÉS MARCHANDES OU À L'UTILISATION DE CE PRODUIT DANS UN BUT PARTICULIER N'EST VALABLE QUE POUR UNE PÉRIODE D'UN AN À COMPTER DE LA DATE D'ACHAT. WAGNER NE SAURAIT ÊTRE TENU RESPONSABLE DES DOMMAGES FORTUITS OU INDIRECTS QUELS QU'ILS SOIENT, QUE CE SOIT POUR INOBSERVATION DE LA PRÉSENTE GARANTIE OU POUR TOUTE AUTRE RAISON. LA GARANTIE NE COUVRE PAS LES ACCESSOIRES.

CET ARTICLE A ÉTÉ CONÇU EXCLUSIVEMENT EN VUE D'UN USAGE DOMESTIQUE. LA GARANTIE NE SERA VALABLE QUE POUR 30 JOURS À COMPTER DE LA DATE D'ACHAT DE L'ARTICLE EST UTILISÉ À DES FINS COMMERCIALES OU DE LOCATION.

Tout article comportant des défauts de fabrication ou de matériaux au cours de la période de garantie applicable peut être retourné en port payé à un centre de service après-vente agréé de Wagner, accompagné de la preuve d'achat (une liste des centres de service après-vente accompagne cet article). Le centre de service après-vente agréé de Wagner vous renverra l'article en port payé, après l'avoir réparé ou remplacé (ce choix étant à la discrétion de Wagner).

COMME LES LIMITES DE TEMPS RELATIVES À UNE GARANTIE TACITE OU À L'EXCLUSION DES DOMMAGES DE NATURE FORTUITE OU INDIRECTE N'ONT PAS NÉCESSAIREMENT COURS DANS TOUTES LES PROVINCES, IL SE PEUT QUE LESDITES LIMITES OU EXCLUSIONS NE VOUS CONCERNENT PAS. CERTAINS DROITS PARTICULIERS VOUS SONT DÉVOLUS EN VERTU DE LA PRÉSENTE GARANTIE ET PEUVENT S'ACCOMPAGNER D'AUTRES DROITS EN FONCTION DE LA PROVINCE OÙ VOUS RÉSIDEZ.

EQUIPO DE ATOMIZACIÓN DE PINTURA HVLP

Este producto, fabricado por la Wagner Spray Tech Corporation (Wagner), está garantizado contra defectos de materiales y de mano de obra por un año a partir de la fecha de compra siempre y cuando se utilice de acuerdo con las recomendaciones e instrucciones impresas de Wagner. Esta garantía no cubre daños ocasionados por el uso incorrecto, accidentes, negligencia por parte del usuario o el desgaste normal. Esta garantía no cubre cualquier defecto o daño ocasionado por el servicio o las reparaciones llevadas a cabo fuera de un Centro de Servicio Wagner Autorizado.

CUALQUIER GARANTÍA IMPLÍCITA REFERENTE AL POTENCIAL COMERCIAL O ADAPTABILIDAD PARA UN USO PARTICULAR SE LIMITA A UN AÑO A PARTIR DE LA FECHA DE COMPRA. WAGNER EN NINGÚN CASO SERÁ RESPONSABLE DE CUALQUIER DAÑO DIRECTO O INDIRECTO DE CUALQUIER TIPO, YA SEA POR VIOLACIÓN DE ESTA GARANTÍA O CUALQUIER OTRA RAZÓN. ESTA GARANTÍA NO SE APLICA A LOS ACCESORIOS.

ESTE PRODUCTO ESTÁ DISEÑADO PARA SER UTILIZADO EN EL HOGAR ÚNICAMENTE. SI SE UTILIZA PARA PROPÓSITOS COMERCIALES O DE ALQUILER, ESTÁ GARANTÍA ES VÁLIDA ÚNICAMENTE DURANTE 30 DÍAS A PARTIR DE LA FECHA DE COMPRA.

Si cualquier producto está defectuoso con respecto a los materiales o mano de obra, regréselo porte pagado junto con el recibo de compra a cualquier Centro de Servicio Wagner Autorizado (la lista de Centros de Servicio se adjunta con este producto). El Centro de Servicio Wagner Autorizado reparará o reemplazará el producto (a la discreción de Wagner) y se lo regresará porte pagado.

ALGUNOS ESTADOS, DEPARTAMENTOS O PROVINCIAS NO PERMITEN LIMITACIONES EN CUANTO AL PERÍODO DE VALIDEZ DE UNA GARANTÍA IMPLÍCITA NI LA EXCLUSIÓN DE DAÑOS DIRECTOS O INDIRECTOS. POR LA TANTO, LA LIMITACIÓN Y LA EXCLUSIÓN ANTERIOR PUEDEN NO APLICARSE A USTED. ESTA GARANTÍA LE OTORGA DERECHOS LEGALES ESPECÍFICOS Y USTED TAMBIÉN PUEDE TENER OTROS DERECHOS QUE VARIAN DE UNA LOCALIDAD A OTRA.

CONTROL SPRAY™ 250